

Low Power Long Range RF Transceiver Module

SPECIFICATION

Model No.: DL-RFM95/DL-RFM96

Version: V1.0



Model: DL-RFM95
868MHz/915MHz

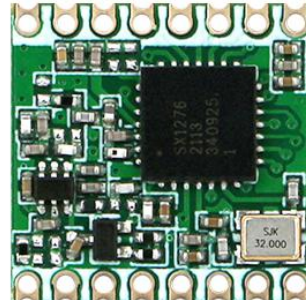

Model: DL-RFM96
433MHz/470MHz

Before using this module, please pay attention to the following important matters:

This RF module is an electrostatic sensitive product, which should be used in a dry environment. Please operate it on an anti-static workbench during installation and testing, and make sure no liquid substance come into this module.

This DL-RFM95/DL-RFM96 wireless module uses an external antenna by default, which is intended to be embedded in your product or application, and does not provide a casing itself. The antenna can be a spring antenna or a FPC antenna. You can choose a specific antenna according to the actual situation.

Metal objects and wires should be kept away from the antenna as much as possible. If the product uses a metal shell, be sure to install the antenna outside the metal shell. Otherwise, the RF signal will be seriously attenuated, which will affect the effective distance.

Please use an independent voltage regulator circuit to supply power to this module, and avoid sharing with other circuits. The tolerance of the power supply should not be less than 5%.

Disclaimer:

This specification is just for your information, all the charts and pictures used in this specification are for reference only. The actual test shall prevail for details. We do not assume any responsibility for personal injury or property loss caused by user's improper operation.

This specification is subject to change due to the continuous improvement and upgrading of the product version, and the latest version specification shall prevail. DREAMLNK reserves the right of final interpretation and modification of all contents in this specification.

Date	Version	Formulation / Revision of Contents	Approved by
2017-5-20	V1.0	DL-RFM95/DL-RFM96 Standard Version RF Module	Fagan Xu

1. Module Introduction

1.1 Brief Introduction

The DL-RFM95/DL-RFM96 wireless modules are designed with Semtech's LoRa Spread Spectrum Chip SX1276. Using LoRa modulation technique, these DL-RFM95/DL-RFM96 transceivers feature the LoRa long range modem that provides ultra-long range spread spectrum communication and high interference immunity whilst minimising current consumption. LoRa also provides significant advantages in both blocking and selectivity over conventional modulation techniques, solving the traditional design compromise between range, interference immunity and energy consumption.

The receiving sensitivity of the DL-RFM95/96 wireless modules can achieve -148dBm. Its high sensitivity combined with integrated +20dBm power amplifier can greatly improve the link budget, can cope with the signal attenuation caused by complex environment, making it an ideal choice for long-distance and stable performance applications. It also has high performance (G) FSK modulation mode and supports systems such as WMBus and IEEE802.15.4g.

Moreover, these DL-RFM95/96/98 wireless modules deliver exceptional phase noise, selectivity, receiver linearity and IIP3 for significantly lower current consumption than competing devices.

Comparison Table of Main Parameters of these 2 LoRa Modules (DL-RFM95 & DL-RFM96):

Model No.	Frequency	Working Voltage	TX Current	RX Sensitivity
DL-RFM95	868/915MHz	1.8-3.7V	120mA@+20dBm	-111 to -148dBm
DL-RFM96	433/470MHz	1.8-3.7V	120mA@+20dBm	-112 to -148dBm

1.2 Features

- 3000m transmission distance
- Working frequency: DL-RFM95: 868MHz/915MHz; DL-RFM96: 433MHz/470MHz; other frequencies can be customized
- High Sensitivity: maximum -148dBm
- 168 dB maximum link budget.
- +20 dBm ~ 100 mW constant RF output vs. 3.3V supply.
- Programmable bit rate up to 300kbps@FSK
- FSK, GFSK, MSK, GMSK, LoRa and OOK modulation modes
- Transmission rate: 1.2-300 Kbps @ FSK; 0.018-37.5 Kbps @ Lora

- Bullet-proof front end: IIP3 = -12.5 dBm.
- Excellent blocking immunity.
- Low RX current of 10.8 mA, 200nA register retention.
- Fully integrated synthesizer with a resolution of 61Hz.
- Built-in bit synchronizer for clock recovery.
- Preamble detection.
- 127 dB Dynamic Range RSSI.
- Automatic RF Sense and CAD with ultra-fast AFC.
- Packet engine up to 256 bytes with CRC.
- Built-in temperature sensor and low battery indicator.
- Module Size:16X16mm

1.3 Typical Application

- Wireless automatic meter reading (water meter, electric meter, gas meter)
- Ultra-long distance data communication
- Home and Building Automation
- Intelligent security monitoring
- Wireless Sensor Networks
- Industrial Monitoring and Control
- Agricultural automation solutions
- Remote control and telemetry of field data
- All kinds of transmitter, flow meter intelligent instrument
- Wireless Alarm and Security Systems
- Wireless M-BUS

2. Technical Parameter

Parameter	Min.	Typical	Max.	Unit	Remarks
Operating conditions					
Working Voltage	1.8	3.3	3.7	V	
Working Temperature	-20		70	°C	
Current consumption					
Receiving Current		10.8		mA	
Transmission Current		120		mA	+20dbm
Standby Current		<1		uA	
RF parameters					

Frequency Range	410		525	MHZ	DL-RFM96
	820		1020	MHZ	DL-RFM95
Modulation Frequency	1.2		300	Kbps	FSK modulation
	0.018		37.5	Kbps	LoRa modulation
Transmission Power	-1		+19.5	dBm	
Receiving Sensitivity		-123		dBm	@FSK data=1.5kbps, Fdev=10kHz
		-146		dBm	@Lora BW=10.4kHz, SF=11

Table 1: Technical Parameter

3. Pin Definitions

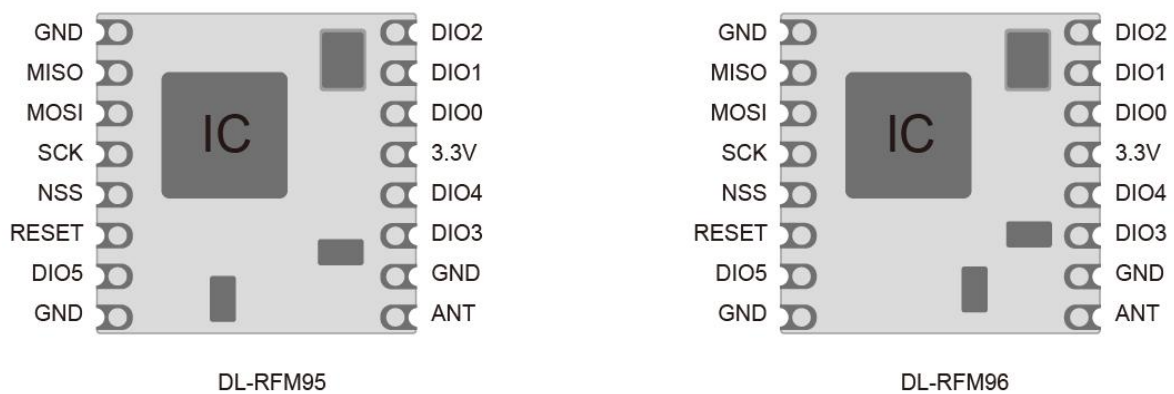

DL-RFM95 / DL-RFM96 Pin Definitions

Number	Name	Type	Description
1	GND	-	Ground
2	MISO	O	SPI Data output
3	MOSI	I	SPI Data input
4	SCK	I	SPI Clock input
5	NSS	I	SPI Chip select input
6	RESET	I	Reset trigger input, low level to reset
7	DIO5	I/O	Digital I/O, software configured
8	GND	-	Ground
9	ANT	-	RF signal output/input.
10	GND	-	Ground
11	DIO3	I/O	Digital I/O, software configured
12	DIO4	I/O	Digital I/O, software configured
13	3.3V	-	Supply voltage

14	DIO0	I/O	Digital I/O, software configured
15	DIO1	I/O	Digital I/O, software configured
16	DIO2	I/O	Digital I/O, software configured

Table 2: DL-RFM95/DL-RFM96 Pinouts

4. Module Size & SMT

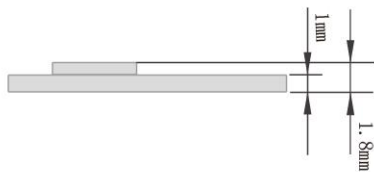
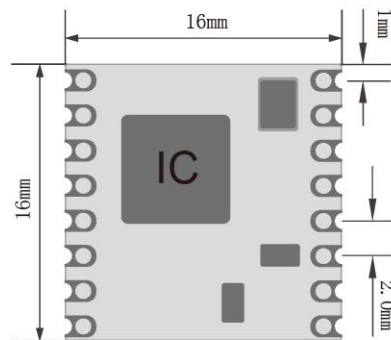
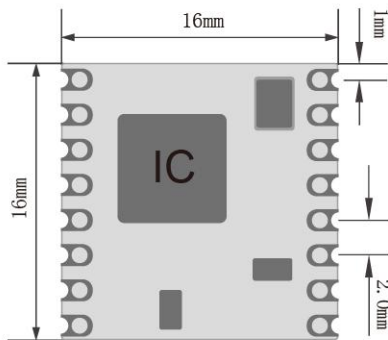

DL-RFM95

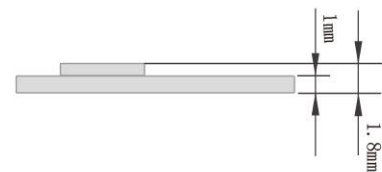

DL-RFM96

DL-RFM95/DL-RFM96 Package Outline Drawing

Please apply for module packaging from our technical support: SMT patch package, DIP in-line package file (refer to schematic diagram)

Package files format description:

- * .ASC format can be opened with Protel99se;
- * .DXF format can be opened with CAD;
- * .PCB format can be opened with PADS software;

Module packaging: SMT placement (steel mesh thickness $\geq 1.2\text{mm}$)

5. Application Connection Diagram

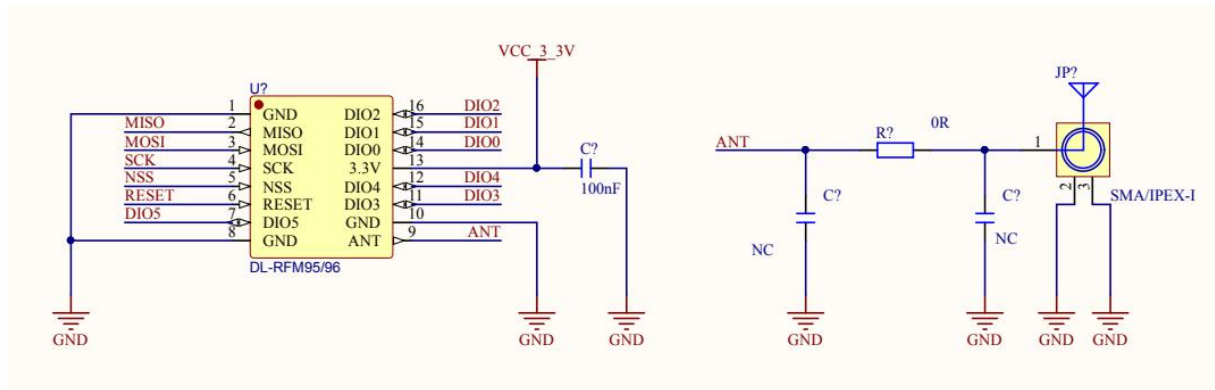

Note: This schematic diagram is for your reference only. If you have any question, please contact us for more help.

6. Circuit Design

6.1 Power Supply Design

- Please pay attention to the power supply voltage of the device, exceeding the recommended voltage range may cause function abnormally and permanent damage;
- Try to use a DC stabilized power supply, and the power ripple coefficient should be as small as possible; the power load when transmitting the maximum power needs to be also considered;
- The module needs to be grounded reliably, and a good grounding can achieve better performance output and reduce the impact of RF on other sensitive devices.

6.2 RF Routing Design

- The module should be far away from RF interference sources, such as high-frequency circuit transformer, and it is forbidden to route the wires directly under the module, otherwise it may affect the receiving sensitivity;
- When using the on-board antenna, the antenna needs to be clear on both sides, and the ground should not be too close to the antenna at the same time, otherwise it will absorb the radiated energy;
- Route 50Ω impedance line, lay the ground and drill more ground holes;
- The PCBA space allows to reserve a π -type matching network, first connect it through a 0R resistor, otherwise the antenna is open.

6.3 Antenna Design

- There are many types of antennas, choose the appropriate antenna according to your needs;

- Choose a suitable placement position, according to the Antenna polarity, and it is recommended to be vertically upward;
- There should be no metal objects in the antenna radiation path, otherwise the transmission distance will be affected (such as a closed metal casing).

6.4 I/O design

- Please pay attention to level conversion, if 5V I/O voltage used;
- Not all the 6 DIOx pins of DL-RFM95/DL-RFM96 need to be connected;
- When doing the hardware design, for the data packet mode (SPI transmission), lead DIO0, DIO2 (can receive data packets, detect synchronization code and other functions) out is enough, which can meet most applications;
- For details, please refer to the chip manual: Table 30 DIO Mapping, Packet Mode

7. Notice for module application

- (1) This module is an electrostatic sensitive product. Please operate on an anti-static workbench during installation and testing;
- (2) When installing the module, ensure that nearby objects keep a sufficient safe distance from the module to prevent short-circuit damage;
- (3) Never allow any liquid substance to come into contact with this module, and this module should be used in a dry environment;
- (4) Please Use an independent voltage stabilizing circuit to supply power to this module, and avoid sharing with other circuits. The tolerance of the power supply should not be less than 5%.
- (5) The indicators of this module are accord to commonly used international standard. If special certifications needed, we can adjust certain indicators according to your needs.